

Seaward PV150+

USER MANUAL



seaward.com

TESTED. TRUSTED... WORLDWIDE

LIMITED WARRANTY & LIMITATION OF LIABILITY

SEAWARD Electronic Limited guarantees this product to be free from defects in material and workmanship under normal use and service for a period of 2 years, provided the instrument is serviced and calibrated by an authorised agent in accordance with the manufacturer's instructions. The period of warranty will be effective at the day of delivery.

Manufacturer does not provide any warranty for the following:

- Any normal wear and tear.
- Errors or damage caused by: (i) misuse or not using your product in accordance with the user guide, such as if the product has been exposed to moisture, to dampness or to extreme thermal or environmental conditions or to rapid changes in such conditions, to corrosion, to oxidation, to spillage of food or liquid or to influence from chemical products, (ii) using your product with, or connecting it to, any product, accessory, software, or service not manufactured or supplied by the manufacturer, (iii) any products combined with your product by a third party, (iv) damage or errors caused by hacking, cracking, viruses, or other malware, or by unauthorised access to services, accounts, computer systems or networks; or (v) other acts beyond the manufacturer's reasonable control.

This Warranty is not valid:

- If your product, or the software it runs on, has been (i) opened, modified, or repaired without the manufacturer's authorisation, or (ii) repaired with unauthorised spare parts.
- If you have not installed the latest software updates that are publicly available for your product within a reasonable time of their release; or
- If you refuse to give possession of the product to the manufacturer for repair and investigation.

(c) Copyright 2023

All rights reserved. Nothing from this edition may be multiplied, or made public in any form or manner, either electronically, mechanically, by photocopying, recording, or in any manner, without prior written consent from SEAWARD Electronic Limited. This also applies to accompanying drawings and diagrams.

Due to a policy of continuous development SEAWARD Electronic Limited reserves the right to alter the equipment specification and description outlined in this publication without prior notice and no part of this publication shall be deemed to be part of any contract for the equipment unless specifically referred to as an inclusion within such contract.

TABLE OF CONTENTS

	CERTIFICATE OF CONFORMITY	5
	Introduction	6
1.	User Notes	6
2.	Safety Notes	6
3.	Accessories	7
4.	Unit Description	8
4.1	Identifying parts of the unit	9
4.2	LCD display	10
5.	Using the Solar Installation PV150+	11
5.1	Power On PV150+	11
5.2	Battery Condition Check	11
5.3	Protective Earth Resistance (Rpe) Function	11
5.3.1	Test lead resistance null	11
5.3.2	Resistance measurement	12
5.3.3	Voltage measurement	13
5.4	Auto Sequence Measurement	14
5.5	Memory Store	15
5.6	Memory Recall	15
5.7	Memory Clear	16
5.8	Operating Current	16
5.9	DC Operating Power	17
5.10	Auto Shutdown	18
5.11	Error Messages	18
5.11.1	User serviceable error codes	18
5.11.2	Non-user serviceable error codes	18
6.	Use with the Solar Survey 200R	19
6.1	Pairing with the Survey 200R	19
6.2	Un-Pairing from the Survey 200R	19
6.3	Put the Survey 200R into transmit mode	19
6.4	Normal operation	19
6.5	Downloading data to PC	20
7.	Electrical Specifications	21
7.1	Open Circuit Voltage Measurement (PV Terminals)	21

7.2	Short Circuit Current Measurement	21
7.3	Maximum Power	21
7.4	Earth Continuity	21
7.5	Insulation Resistance	22
7.6	Rpe Voltage Measurement (4mm Terminals)	22
7.7	Operating Current (via AC/DC Current Clamp)	22
7.8	DC Power (via AC/DC Current Clamp)	22
8.	Environmental Conditions	22
9.	Maintenance	23
9.1	Preparing to work on the PV150+	23
9.2	Securing the PV150+	23
9.3	Cleaning the PV150+	23
9.4	Battery Replacement	24
9.5	Replacing the Fuse	24
9.6	Service and Calibration	25
9.7	Spare Parts.	25
	Appendix A	26
	Contact details	27

CERTIFICATE OF CONFORMITY

The certificate of conformity is available from [Seaward.com](https://seaward.com)

[Declarations of Conformity | Seaward](#)



INTRODUCTION

The Seaward PV150+ is a handheld, battery powered, multi-function solar photovoltaic installation test instrument capable of performing all of the electrical tests required by IEC 62446, including:

Earth continuity @ 200mA
Open circuit module, string or array voltage
Voltage polarity
Short circuit module, string or array current
Insulation resistance at 250V, 500V and 1000V
AC or DC Operating current

1. User Notes

This instrument and its operating instructions are intended for use by adequately trained and competent personnel wearing suitable personal protective equipment.

The following symbols are used in these operating instructions and on the Seaward PV150+.



Warning of electrical danger!

Indicates instructions must be followed to avoid danger to persons.



Important, follow the documentation!

This symbol indicates that the operating instructions must be adhered to in order to avoid danger.

2. Safety Notes

In order to ensure safe operation of this instrument, all notes and warnings in these instructions must be observed at all times.



The PV150+ is intended for use in a dry environment only.



The PV150+ RED and BLACK 4mm test terminals may be used to make measurements on circuits rated up to CAT III 300 V AC/DC with reference to earth. Do not connect the PV150+ to voltages which may exceed this rating.



The PV test terminals maximum rating: 1000V DC open circuit voltage, 15A short circuit current, 10kW DC power. Do not exceed this rating. The DC supply must be isolated from earth during testing.



High voltages are present at the probe tips of the PV150+ during insulation resistance measurement. Always hold test probes behind the hand guards.



Check the PV150+ and all associated cables and leads before operating the equipment. Do not use if there are signs of damage.
Only use the test leads supplied with the PV150+.



Do not touch any exposed metal parts of the solar PV installation during testing.



Always ensure that the circuit under test is electrically isolated from the mains supply before attempting an earth resistance measurement.



Do not leave the PV150+ permanently connected to a PV installation. Always disconnect all test leads immediately after use.



Do not test with optimisers connected



Do not attempt to turn off the PV150+ while tests are active.

Where safe operation of the PV150+ is no longer possible it should be immediately shut down and secured to prevent accidental operation.

It must be assumed that safe operation is no longer possible:

- if the instrument or leads show visible signs of damage or
- the instrument does not function or
- after long periods of storage under adverse environmental conditions.



If the PV150+ is being used to determine the presence or absence of hazardous voltages, always prove the operation of voltage measurement function before and after use by means of a known voltage source or proving unit.



The PV150+ is not intended for continuous use. When the PV150+ is not being used disconnect it from the system under test.



If the PV150+ is used in a manner not specified by this document, then the protection provided by the equipment may be impaired.



Do not open unit, no other user serviceable parts.

3. Accessories

3.1 Standard Contents

The PV150+ test kit is supplied with the following items:

- 1 off PV150+ unit
- 1 off professional carry case
- 1 set 1.2 M red and black test lead with test probe and alligator clip 1 set
- MC4 PV test lead adaptors
- 1 off Quick Reference Guide
- 6 off MN1500 (AA) 1.5v Batteries 1 off current clamp adapter

3.2 Optional Accessories

- 500mA FA1000V Fuse

4 Unit Description

The PV150+ is a handheld, multi-function electrical installation test instrument.

4.1 Identifying parts of the unit

The numbering below refers to figure 1 and figure 2.

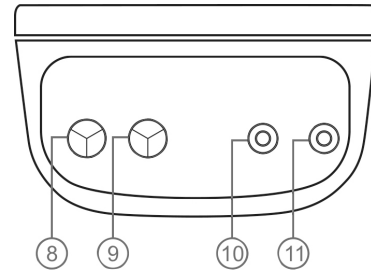
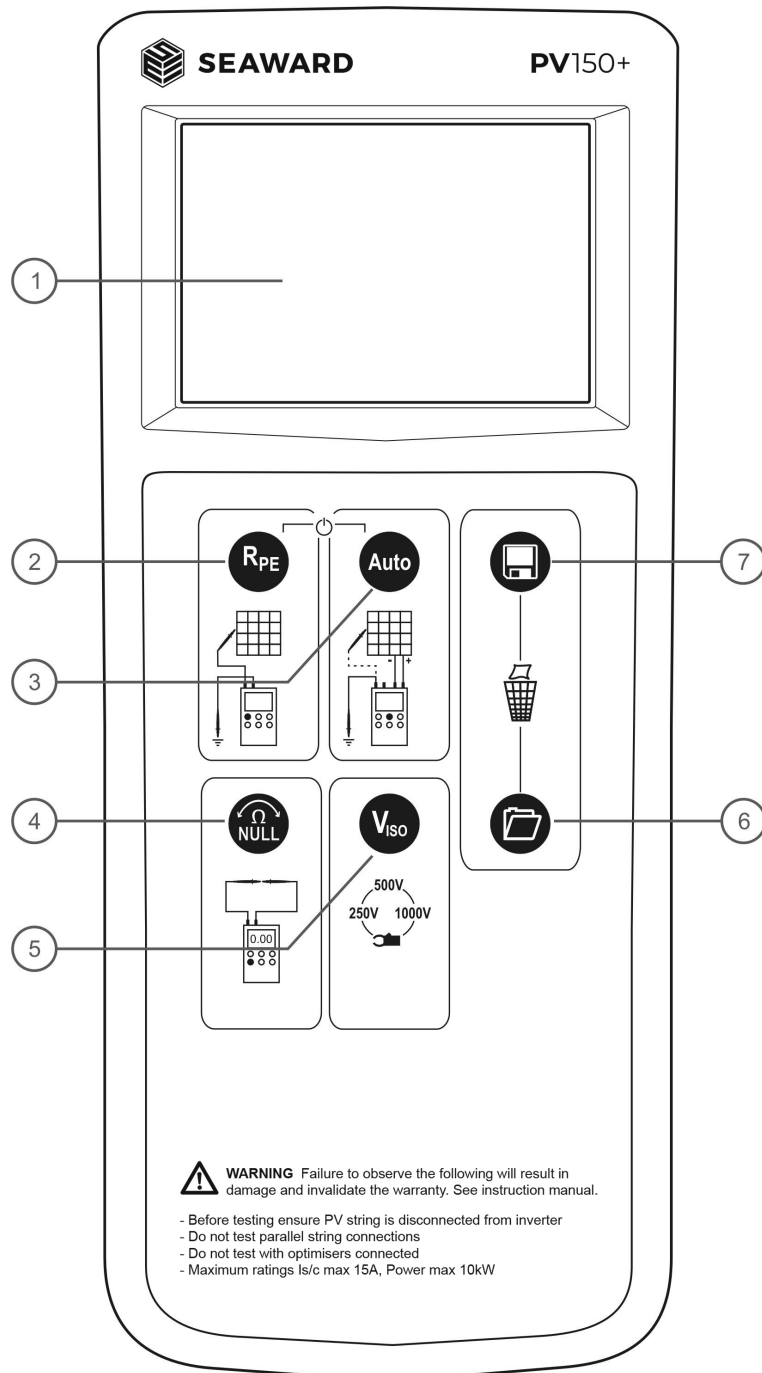

Figure 2 PV150+ End view

1. LCD Display
2. Rpe test key
3. Auto test sequence key
4. Test lead resistance null key
5. Insulation test voltage select key
6. Memory recall key
7. Memory store key
8. +ve PV test lead input (RED)
9. -ve PV test lead input (BLACK)
10. +ve 4mm test lead input (BLACK)
11. -ve 4mm test lead input (RED)

4.2 LCD display

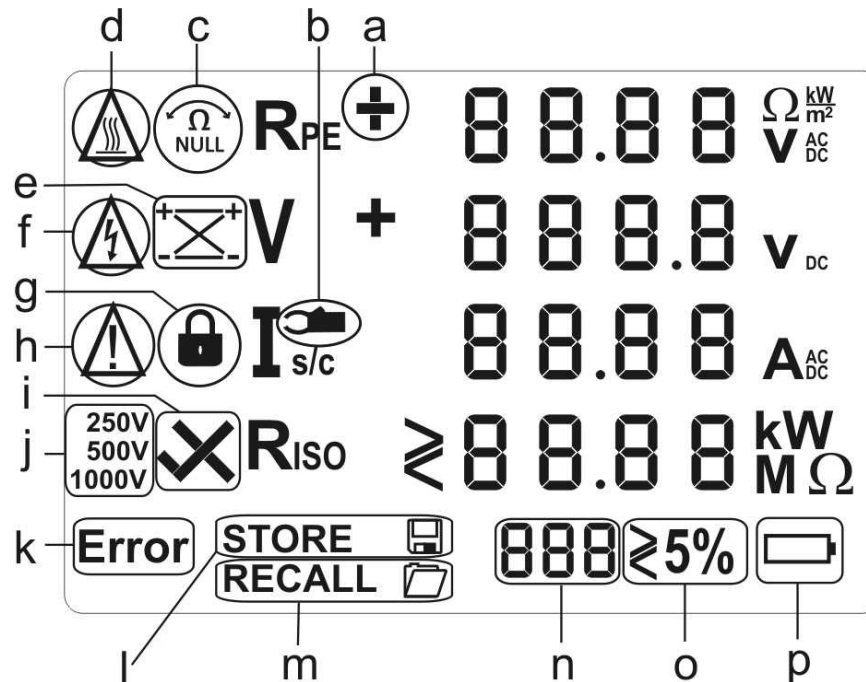

Figure 3 LCD display icons

- a. Rpe voltage polarity. For AC voltages alternating + and - is shown.
- b. Current clamp measurement active.
- c. Rpe Null offset - indicates that test lead resistance offset is active.
- d. Caution - hot surface. If this icon appears, the PV150+ must be disconnected immediately from the PV system until the icon is no longer shown on the LCD.
- e. Solar module polarity indicator - indicates the polarity of the DC voltage applied to the PV test terminals e.g. correct or reversed
- f. Caution - hazardous voltage detected.
- g. Rpe test lock - active when continuous Rpe measurement has been enabled.
- h. Caution - refer to operating instruction. When this icon is active, the operating instructions must be followed to avoid risk of danger.
- i. Riso PASS/FAIL - indicates whether the measured insulation resistance is above or below the factory set acceptable value.
- j. Insulation Test Voltage selection - indicates the test voltage selected for insulation resistance measurements.
- k. Error - Refer to the specific error codes for further details.
- l. STORE - LCD data is being stored in the onboard memory
- m. RECALL - the data shown on the LCD has been recalled from the onboard memory.
- n. User Memory display - indicates the memory location of the results stored or recalled on the LCD.
- o. Voltage/current variation - indicates in the measured voltage and current values deviate by more than or less than 5%.
- p. Battery status icon.

5 Using the PV150+

5.1 Power PV150+

To turn the PV150+ on, press and hold the Rpe and Auto buttons simultaneously.

5.2 Battery Condition Check

The PV150+ automatically performs battery condition checks whilst idle and during measurements. When the battery level is low, the battery symbol icon will appear on the PV150+ display. The PV150+ will continue to function, however the batteries should be replaced.

Note: When the battery symbol icon is flashing all tests will be inhibited and the batteries must be replaced immediately as described in section 8.4.

5.3 Protective Earth Resistance (Rpe) Function



Always ensure that the circuit under test is electrically isolated.



If the test probes are connected to a voltage >5V, the measured voltage will be displayed on the LCD. If the voltage exceeds 30V the Rpe measurement function is inhibited.

5.3.1 Test lead resistance null

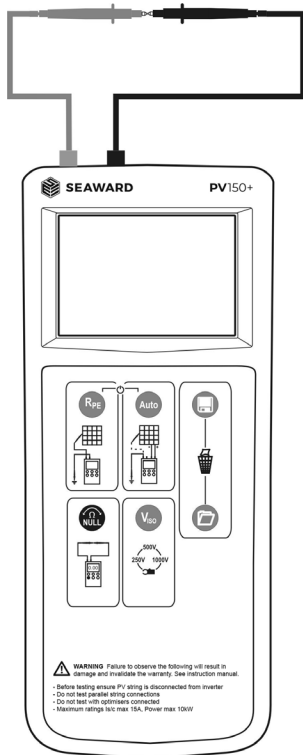

The PV150+ can automatically compensate for the resistance of the test leads using the following procedure:

1. Hold the tips of the test probes firmly together as shown, ensure a good electrical connection.
2. Press and hold the Rpe Null key (4).
3. The measured resistance of the test leads is shown in the primary display until a beep is heard.
4. The Rpe display will now 0.00 and the Null icon is illuminated.
5. All subsequent measurements will take into account the test lead resistance compensation until the function is disabled by pressing the Rpe Null key (4).

Note: A maximum test lead resistance of 10Ω ohms can be taken into account. If the test lead resistance is greater than 10Ω an error beep will indicate that the lead Zero function has failed.

Note: For ease of use, the PV150+ will store the lead compensation when switched off and recall this value when next switched on. The stored value is only applicable to the test leads used when the compensation measurement was made. If the test leads are replaced the Rpe null function should be repeated using the replacement test leads.

5.3.2 Resistance measurement

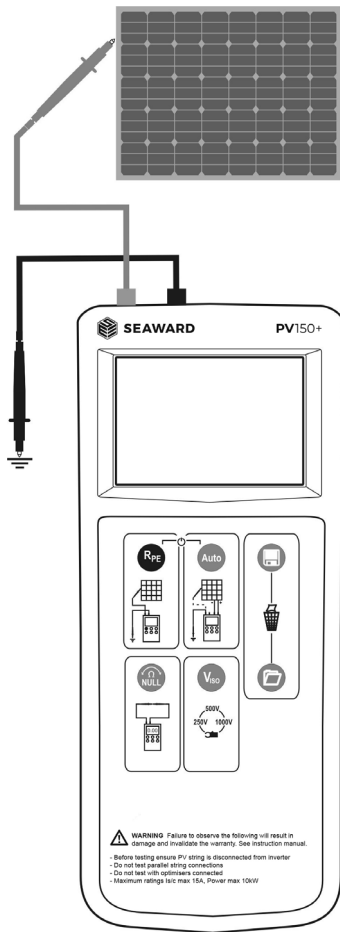

To make a single measurement:

1. Connect the red and black test leads as shown.
2. Press the Rpe key.
3. The resistance between the test probes is displayed.

To make a continuous measurement:

1. Connect the red and black test leads as shown.
2. Press and hold the Rpe key until the lock icon appears on the LCD.
3. The resistance between the test probes is displayed.
4. Press the Rpe key to terminate the continuous measurement mode.

Note: Do not connect the PV150+ to a voltage source while performing the resistance measurement as this will blow the fuse located in the battery compartment.

5.3.3 Voltage measurement

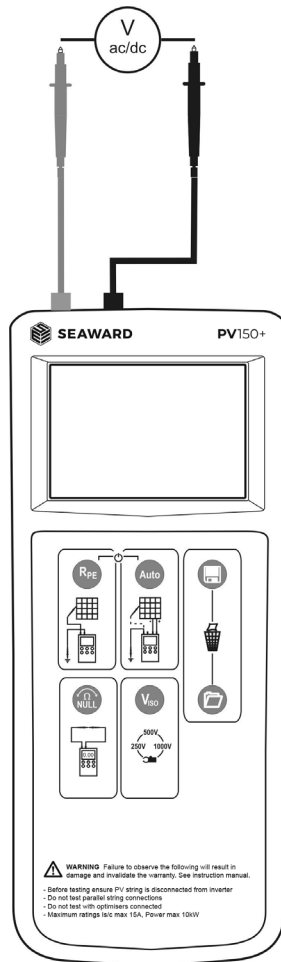

1. Connect the red and black test probes to a voltage source
2. The PV150+ will automatically measure the voltage between the probes.
3. The polarity of the voltage is shown using the icon next to the Rpe icon
4. If the measured voltage is AC, alternating + and - is shown

5.4 Auto Sequence Measurement



Always ensure that the circuit under test is electrically isolated from the mains supply.



Due to the high input impedance of the red 4mm test terminal, voltage caused by leakage currents may be measured prior to starting a test.



Do not attempt to turn off the PVI50+ while tests are active.

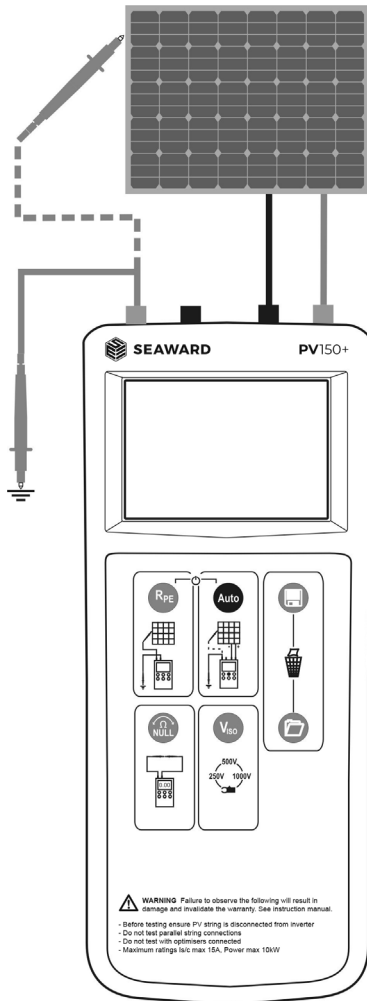

1. Connect the PVI50+ to the PV module as shown, using the supplied test lead adaptors.
2. The red test probe should be connected to earth. Where the structure/frame is bonded to earth, the earth connection maybe to any suitable earth or to the array frame.
3. Where the array frame is not bonded to earth, a commissioning engineer may choose to do two tests:
 - I. Between array cables and earth
 - II. Between array cables and frame
4. The PVI50+ will automatically detect any DC voltage connected to the PV test socket inputs 8 and 9 and display the measured voltage.
5. If the PV voltage polarity is reversed, the polarity indicator will flash across next to the voltage icon.
6. If the incoming voltage is >30v then the shock hazard icon will flash.
7. Use the Viso button to select either the 250V, 500V or 1000V insulation test voltage, please refer to relevant standards for testing requirements.
8. Press the Auto button and the PVI50+ will automatically perform the following tests:
 - Open Circuit Voltage
 - Short Circuit Current
 - Insulation Resistance
9. The measurement results will remain on the LCD for 20 seconds or until a key is pressed.
10. A tick or cross will be displayed next to the insulation resistance measurement indicating whether the result is above or below the threshold values shown in Table 1.

Table1

Viso	Pass / Fail Limit
250v	0.5 M ohms
500v	1.0 M ohms
1000v	1.0 M ohms

Note: During the insulation test, the PVI50+ applies a short circuit across the PV string. The insulation test voltage is then applied between the RED 4mm test lead and the two PV test terminals.

Note: If the DC voltage polarity is incorrect or the voltage is <5V or >1000V the Auto Test will be disabled until the problem is corrected.

5.5 Memory Store

The PVI50+ can store up to 200 complete sets of measurements. Press the Memory Store button to store all measured values on the display.

If there is sufficient memory space to store a set of readings, then the Store icon will appear, and the readings will be stored in the next available memory location. If there is insufficient memory space, then the buzzer will sound. If there are no valid readings on the display, then nothing will be stored.

5.6 Memory Recall

Each press of the Recall button will increment the user memory location indicator and display the measured values stored in that memory location. The location number is shown on the bottom of the LCD display. After the first press of Recall, the Store button can be used to decrement the user memory location indicator to recall previous memory location.

Press and hold the Recall button to download data to a PC via the USB port.

5% Variation warning.

If the recall data has a Voc or Isc reading, then the average of all the stored readings is calculated. If the current recalled reading is more than 5% different from the average, then the 5% warning icon will flash.

Average value

Keep pressing the Memory Recall button until the location number is 0. The display now shows the average Voc and Isc. of all stored results.

5.7 Memory Clear

Press the Store and Recall buttons together to clear all the user memory locations.

5.8 Operating Current

The PVI50+ can be used to measure the DC operating current of a solar PV installation as shown.

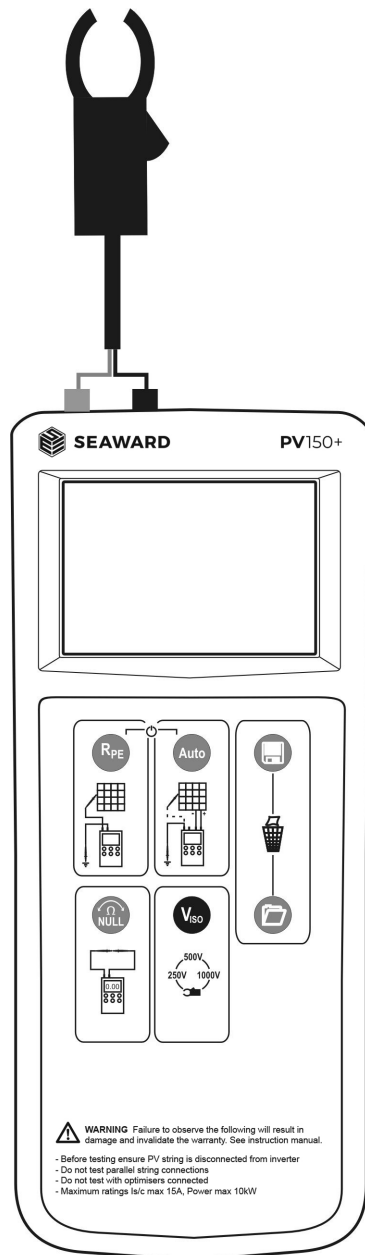

1. Disconnect all cables from the PV test inputs (8 & 9 in figure 2).
2. Connect the current clamp to the red - black 4mm probe inputs.
3. Move the current clamp switch to the 40A position.
4. Press the zero button on the current clamp for a few seconds.
5. Place the clamp around the DC cable of the solar installation.
6. Press the Viso button until the clamp icon (figure 3, icon b) appears on the LCD.
7. The measured current is shown on the LCD next to the clamp icon.

5.9 DC Operating Power

The PVI50+ can be used to measure the DC operating power of a solar PV installation as shown.

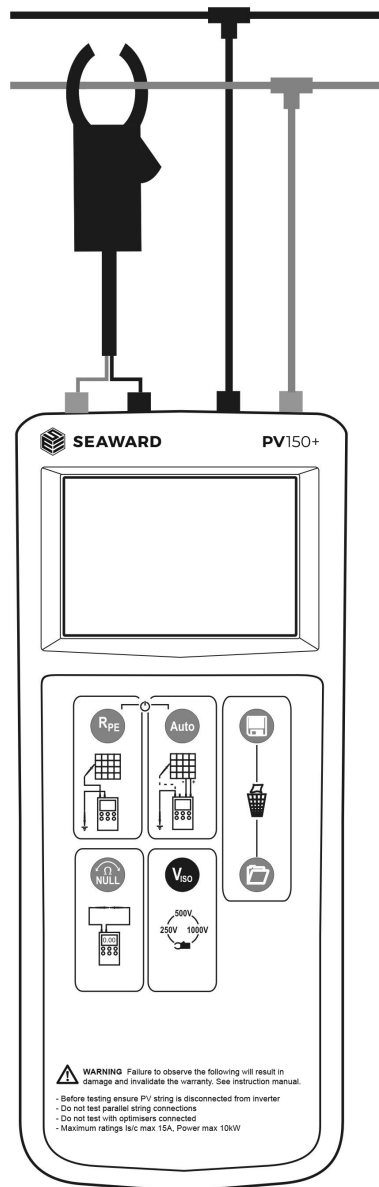

1. Disconnect all cables from the PV test inputs (8 & 9 in figure 2).
2. Connect the current clamp to the red - black 4mm probe inputs.
3. Move the current clamp switch to the 40A position.
4. Press and hold the zero button on the current clamp for a few seconds.
5. Place the clamp around the DC cable of the solar installation.
6. Press the Viso button until the clamp icon (figure 3, icon b) appears on the LCD.
7. The measured DC current is shown on the LCD next to the clamp icon.
8. Connect the PV voltage to the PV inputs. 'T' or 'Y' test adaptors are required if the DC power is to be measured whilst the PV system is operational.
9. The DC Voltage, current and power will be displayed

Note: *The Auto button is disabled whilst the DC power measurement is in use. Under no circumstances should and Auto test sequence be attempted whilst the PVI50+ is connected to the inverter DC inputs as this may result in damage to the instrument.*

5.10 Auto Shutdown

After 1 minute of being idle the PV150+ will turn itself off in order to conserve battery power. This auto shutdown period can be extended as follows:

1. Turn the PV150+ unit off
2. Press and hold the NULL key, then press both the ON/OFF keys together. Keep holding the NULL key.
3. The display will show "OFF" on line 1, and the turnoff time on line 2 (in minutes)
4. Keep holding the NULL key and press the Viso key. Each press of the Viso key will increment the turnoff time.
5. Increment beyond 10 to set the time back to 1 minute

Note: *When displaying DC Operating Power (section 5.9) the Auto Shutdown function is deactivated whilst DC voltage or current are detected. This will allow extended time for monitoring DC power.*

5.11 Error Messages

Under certain conditions, the PV150+ may indicate an error message.

5.11.1 User serviceable error codes

Error message	Remedy
FUSE	The internal fuse has blown. Refer to section 8.5 in the operating instructions for details on how to replace the fuse.
HOT	The electronics within the PV150+ have reached the maximum safe temperature. This can occur after repeated short circuit current measurements at high current levels. Allow the unit to cool down before further use.
HISC	The DC short circuit current has exceeded the maximum rated value of 15A. The measurement sequence has been aborted.
HIOC	High Open Circuit Voltage (i.e., > 1000V), check supply voltage, if above 1000V cease testing.

5.11.2 Non-user serviceable error codes

Error message	Remedy
CAL	The PV150+ is not correctly calibrated. Return the unit to an authorised Service Agent.
Er 1,2 etc	Return the unit to an authorised Service Agent.
HOTF	Return the unit to an authorised Service Agent.
FET	Return the unit to an authorised Service Agent.
rL 1,2,3 or 4	Return the unit to an authorised Service Agent.

6 Use with the Solar Survey 200R

6.1 Pairing with the Survey 200R

Make sure there are no other units operating nearby. Turn off both the PV150+ and Survey 200R unit.

On the Survey 200R, press and hold the On/Off keys, keep both keys pressed.

On the PV150+, press and hold the Rpe and Auto keys, keep both buttons pressed.

The Survey 200R will now send its "Pairing" signal. When the PV150+ detects this signal, it will remember the serial number of the Survey 200R and will look for that particular serial number in all future communications.

When the PV150+ has successfully paired, it will beep and display the serial number of the Survey 200R. This should normally happen within a couple of seconds.

Note: The top line of the PV150+ display will now show the W/m² icon.

6.2 Un-Pairing from the Survey 200R

Make sure there are no other units operating nearby. Turn the PV150+ off.

On the PV150+, press and hold the Rpe and Auto keys, keep both buttons pressed for about 10 seconds. The PV150+ will then beep and clear its screen. The unit is now no longer paired to any Survey 200R. Note that the top line of the LCD will display Rpe ohms.

6.3 Put the Survey 200R into transmit mode

The Survey 200R can be put in and out of transmit mode by pressing and holding the temperature key, and then momentarily pressing the OK key.

When in transmit mode there will be a flashing icon above the temperature key.

Note: When in transmit mode the auto shut down feature is disabled. You must remember to turn the Survey 200R off in order to save battery power.

6.4 Normal operation

When the PV150+ has been paired with a Survey 200R, the top line of the display is used to show the irradiance value measured by the Survey 200R.

The Survey 200R must be put into transmit mode as described above.

When the PV150+ is in range of the Survey 200R it will display the Survey 200R irradiance value and display it on the top line of the LCD.

When an Auto test is performed, the PV150+ captures the irradiance, ambient temperature, and module temperature measurements from the Survey 200R. Press Store and all these values will be stored along with any measurements made using by the PV150+.

6.5 Downloading data to PC

Connect the PVI50+ to PC using the USB cable. (This will create a COM port on the PC)

Run the Seaward Solar Datalogger application on the PC. Select the correct COM port. (Use the Help menu – Trouble shooting guide, to help finding the correct COM port)

Click the Download button, and then press and hold the Recall key (6) on the PVI50+. After a few seconds the PVI50+ will transfer all its stored data to the PC.

By default, the Datalogger application will save the data in CSV format. This can be opened using Microsoft Excel. Note that each row of data will have the readings from the Survey 200R where possible.

7 Electrical Specifications

7.1 Open Circuit Voltage Measurement (PV Terminals)

Display Range	0.0VDC - 1000VDC
Measuring Range	5.0VDC - 1000VDC
Resolution	0.1VDC
Accuracy	± (0.5% + 2 digits)

7.2 Short Circuit Current Measurement

Display Range	0.00ADC - 15.00ADC
Measuring Range	0.50ADC - 15.00ADC
Maximum Power	10kW
Resolution	0.01 ADC
Accuracy	± (1% + 2 digits)

7.3 Maximum Power

Maximum Power Rating	10kW
----------------------	------

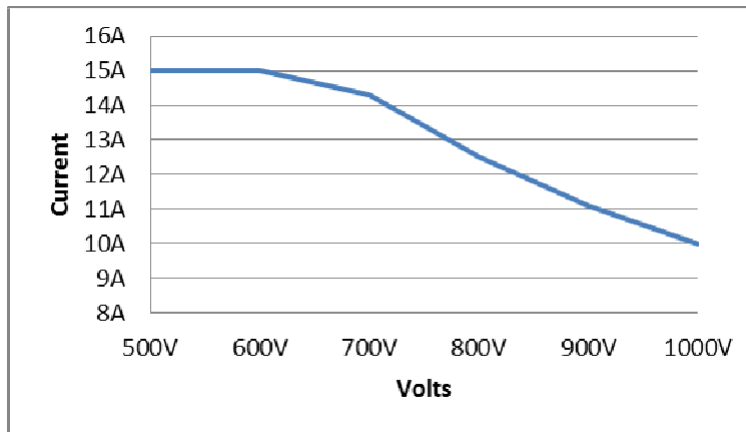

Voltage	Current
<600V	15A
700V	14.2A
800V	12.5A
900V	11A
1000V	10A

7.4 Earth Continuity

Test Voltage Open Circuit	>4V
Test Current into 2Ω	>200mA
Display Range	0.00Ω - 199Ω
Measuring Range (EN 61557-4)	0.05Ω - 199Ω
Resolution	0.01Ω maximum
Accuracy	± (2% + 2 digits)
Number of repeat tests as per IEC61557-4	Approx. 4000

7.5 Insulation Resistance

Test Voltage Specification	-0% +20% (open circuit)
Test Voltage @ 1mA	>1mA into $U_N \times (1000\Omega/V)$
Test Current Short Circuit	<2mA
Display Range	0.05M Ω - 199M Ω
Measuring Range (EN 61557-2)	0.20M Ω - 199M Ω
Resolution	0.01M Ω maximum
Accuracy	0.05M Ω - 100M Ω \pm (5% + 5 digits) 101M Ω -199M Ω \pm (10% + 5 digits)
Number of repeat tests as per IEC61557-2	Approx. 3000

7.6 Rpe Voltage Measurement (4mm Terminals)

Display Range	30V - 440V
Voltage Measuring Range	30V - 440V DC 30V - 440V AC 50-60Hz
Resolution	1V
Accuracy	\pm (5% + 2 digits)

7.7 Operating Current (via AC/DC Current Clamp)

Display Range	0.1A - 40.0A
Current Measuring Range	0.1A - 40.0ADC 0.1A - 40.0AAC 50-60Hz
Resolution	0.1A
Accuracy	\pm (5% + 2 digits)

7.8 DC Power (via AC/DC Current Clamp)

Display Range	0.00kW - 40kW
Measuring Range	0.50kW - 40kW
Resolution	0.01kW
Accuracy	\pm (5% + 5 digits)

8 Environmental Conditions

The PVI50+ has been designed to perform tests and measurements in a dry environment.

Maximum barometric elevation for making measurements is 2000M.

Overvoltage category IEC 60664/IEC 61010, 300V Category III (Red and Black 4mm terminals only).

Pollution degree 2 according to IEC 61010-1.

Protective system IP40 according to IEC 60529.

Electromagnetic compatibility (EMC). Interference immunity and emitted interference conforming to IEC 61326-1.

Operating temperature range of 0°C to 40°C, without moisture condensation.

The PVI50 can be stored at any temperature in the range -25°C to +65°C (relative humidity up to 90%). The batteries should be taken out of the instrument for storage.

Operating Altitude 0 to 2000 meters

9 Maintenance



Before removing the PV150+ battery cover ensure that all test leads have been disconnected from the instrument. Electric shock danger!
Do not operate the PV150+ without the battery cover securely in place.

9.1 Preparing to work on the PV150+

Make sure the PV150+ leads and accessories are disconnected, before opening the instrument.

Power the unit off.

Disconnect all of the test leads from the unit

9.2 Securing the PV150+

Under certain conditions safe operation of the PV150+ can no longer be assumed: Visible damage of the instrument case.

Incorrect measurement results.

Recognisable abuse to the instrument due to prolonged storage under improper conditions.

Recognisable abuse to the instrument due to extraordinary transportation stress. Check the battery compartment for signs of battery electrolyte leakage.

In these cases, the PV150+ should be immediately switched off, disconnected from any test or measurement function and secured to prevent any further use.

9.3 Cleaning the PV150+

Clean the external case of the Solar PV150+ with a clean dry cloth.

Avoid using solvents and abrasive scouring agents to clean the external case of the Solar PV150+.

Check the battery contacts and compartment are free of electrolytic contamination.

Any contamination of the battery contacts or compartment should be cleaned with a dry cloth.

9.4 Battery Replacement



Before opening the PV150+ ensure that it is disconnected from all voltage!
Electric shock danger!

Power the unit off.

Disconnect all the test leads from the unit

Position the PV150+ face down and release the captive screw in the battery compartment cover.

Remove the battery compartment cover.

Remove the discharged batteries from the compartment. Fit a new set of alkaline batteries.

Relocate the battery cover over the battery compartment and fasten in position with the battery cover captive screw.

9.5 Replacing the Fuse



Before opening the PV150+ ensure that it is disconnected from all voltages!
Electric shock danger!



All replacement fuse types are specified for ratings and size on the battery compartment cover on the rear of the PV150+.

Power the unit off.

Disconnect all the test leads from the unit.

Position the PV150+ face down and release the captive screw in the battery compartment cover.

Remove the battery compartment cover.

Lift one end of the fuse out of the fuse holder with the help of a flat bladed screwdriver. Lift the defective fuse completely out of the fuse holder.

Insert a new fuse as described and specified by the text on the battery compartment cover.

Ensure that the new fuse is seated and centered in the fuse holder.

Relocate the battery cover over the battery compartment and fasten in position with the battery cover captive screw.

The Seaward PV150+ panel circuit is protected by a 15A 1000V Solar fuse. This fuse is not operator replicable. If this fuse blows then the Seaward PV150+ will indicate an error before the panel is shorted, the PV150+ must be returned for service.

9.6 Service and Calibration.

To maintain the specified accuracy of the measurement results, the instrument must be recalibrated at regular intervals by either the manufacturer or an authorised Seaward Service Agent. We recommend a recalibration period of one year.

9.7 Spare Parts.

Seaward Part No.

MC4 Test Lead set (Red lead fused, black lead un-fused)	396A959
MC4 Test Lead (Red fused lead)	388A688
MC4 Test Leads with test probes (includes crocodile clips)	388A953



Appendix A

SEAWARD

ELECTRICAL SAFETY TESTING
& MEASURING.

IEC61557-2: Insulation		
Intrinsic error or influence quantity	Reference conditions or specified operating range	Designation code
Intrinsic error	Reference conditions	A
Position	Reference position $\pm 90^\circ$	E ₁
Supply voltage	At the limits stated by the manufacturer	E ₂
Temperature	0°C and 40°C	E ₃
Operating Error	$B = \pm(A + 1.15 \sqrt{E_1^2 + E_2^2 + E_3^2})$	

IEC61557-4: Resistance of earth connection and equipotential bonding		
Intrinsic error or influence quantity	Reference conditions or specified operating range	Designation code
Intrinsic error	Reference conditions	A
Position	Reference position $\pm 90^\circ$	E ₁
Supply voltage	At the limits stated by the manufacturer	E ₂
Temperature	0°C and 40°C	E ₃
Operating Error	$B = \pm(A + 1.15 \sqrt{E_1^2 + E_2^2 + E_3^2})$	

seaward.com

TESTED. TRUSTED... WORLDWIDE

For help or advice on Service and Calibration contact:

Service Department

Seaward Electronic

Bracken Hill

South West Industrial Estate

Peterlee

Co Durham SR8 2SW

England

Tel: 0191 5878739 / 0191 5878737

Email: service@seaward.com

For help or advice on Service and Calibration, in North America contact:

Service, Calibration and Repair

Seaward Group USA

6304 Benjamin Road

Suite 506

Tampa, FL 33634

United States

Tel: 813 886 2775

Fax: 813 886 2754

Email: service@seaward-groupusa.com

Part Number 388A597 | Revision 1.1